

REMstar®

Heated Humidifier

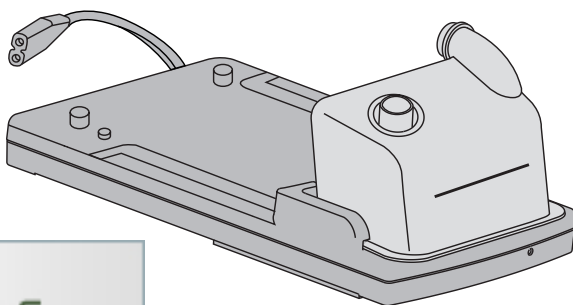

The REMstar Heated Humidifier is for use with certain Respironics CPAP devices. The humidifier moistens the air delivered by the Respironics CPAP devices.



DirectHome
MEDICAL



Presented With Compliments From
www.DirectHomeMedical.com

TABLE OF CONTENTS

Warnings & Cautions	2
Symbols	2
Features	3
Set Up	4
Daily Use	5
Cleaning	6
Service	6
Specifications	7
Traveling	8
Warranty	8

WARNINGS AND CAUTIONS!

IMPORTANT!

Read all instructions before using the humidifier.

Use only with Respronics CPAP devices whose instructions specify the use of this humidifier.

CAUTIONS! Indicates the possibility of damage to the device.

US federal law restricts this device to sale by or on the order of a physician.

If fluids are spilled onto the humidifier platform, unplug the power cord from the AC wall outlet and allow the humidifier platform to drain and dry before using.

Take precautions to protect furniture from water damage.

WARNINGS! Indicates the possibility for injury to the user or the operator.

Use the humidifier only for its intended use as described in this manual.

Use only accessories recommended by Respronics.

Never operate the humidifier if any of the parts are damaged, if it is not working properly, or if the humidifier has been dropped or mishandled. Do not use the humidifier if the water chamber is leaking or damaged in any way. Have any damaged parts replaced before continuing use.

Never touch the heater plate unless the humidifier is unplugged and the plate has cooled down.

This equipment is not suitable for use in the presence of a flammable anesthetic mixture with air or with oxygen or nitrous oxide.

Periodically inspect the power cord for signs of wear or damage. Replace if necessary.

SYMBOLS



Maximum Fill Line



Hot Surface



Type BF Applied Part



Class II (Double Insulated)

IPX0

Ordinary Equipment



Attention, consult accompanying documents



European CE Marking

FEATURES

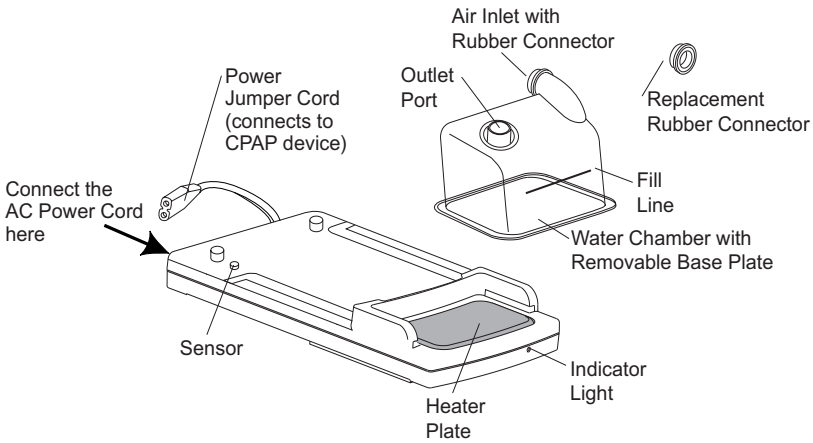

Power Cord: Use the power cord included with your CPAP device.

Power Jumper Cord: Plug this cord into the AC inlet on the Respironics CPAP device.

Heater Plate: Warms the water in the water chamber.

Indicator Light: When lit, this indicates that the heater plate has been turned on.

Air Inlet with Rubber Connector: Connect to the outlet port on the CPAP device.

Outlet Port: Connect the flexible tubing here.

Water Chamber: The removable water chamber holds the water for humidification. It has a removable base plate for ease in cleaning.

Fill Line: This indicates the maximum water level for safe operation.

Sensor: Do not block this sensor. The humidifier will not operate unless it can detect that the CPAP device is positioned correctly.

Replacement Rubber Connector: This can be used if the rubber connector becomes damaged.

SET UP

1. Place the CPAP device on the humidifier platform. Position the CPAP device so that the four feet match up with the humidifier base.

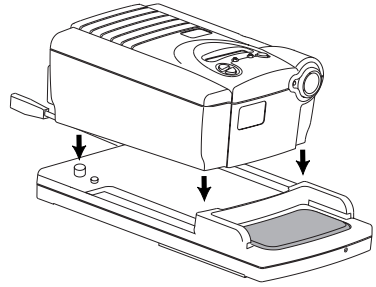

2. Connect the humidifier's power jumper cord to the AC inlet on the device. Plug the CPAP device's power cord into the AC connector on the humidifier. Plug the remaining end of the power cord into an AC outlet.

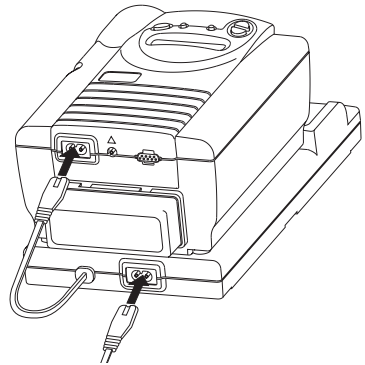

3. Place the CPAP device and humidifier platform on a firm, flat surface at a level lower than your sleeping position.

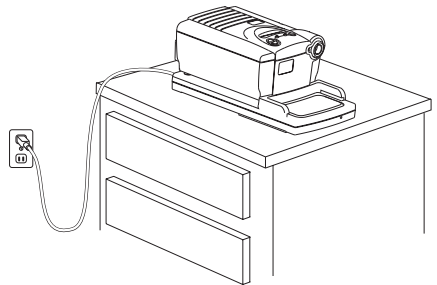

Caution: *Do not turn the humidifier on without the water chamber installed.*

Caution: *Take precautions to protect furniture from water damage.*

DAILY USE

1. Rinse the chamber with water. Fill the chamber to the fill line with water (approx. 1-2/3 cups or 400 ml). Distilled water is recommended. Do not overfill the water chamber.

CAUTION! Always remove the chamber from the humidifier before filling with water.

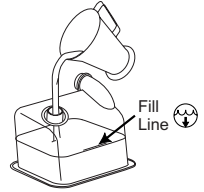

CAUTION! Do not allow the water chamber to sit for any length of time after it has been filled with water. Immediately install the chamber into the humidifier (step 2). Allowing water to sit in the chamber (when it is not connected to the humidifier) may cause the chamber to separate from the bottom plate and water leakage.

2. Press down the spring loaded heater plate with the water chamber and slide the chamber into place. Make sure the rubber connector on the inlet port fits securely over the CPAP device's air outlet.

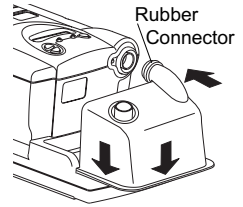

3. Connect the flexible tubing to the outlet port on the water chamber. If pressure tubing is used with your CPAP device, connect the pressure tubing to the pressure outlet on the front of the CPAP device.

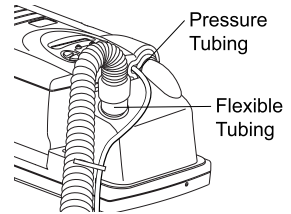

CAUTION! Avoid moving or tilting the humidifier when the water chamber has water in it.

4. Preheat the water before turning on the air flow and before going to bed. Press the humidifier button on the CPAP device. The humidifier symbol will appear on the display screen and the green indicator light on the platform will turn on.



IMPORTANT! The preheat mode will end after 20 minutes if the air flow is not turned on. If you do not wish to preheat the water, you can press the humidifier button after the air flow is turned on.

5. The ideal humidity setting depends on room temperature and humidity. Initially, a setting of 2 is recommended. You can adjust this setting at any time. Press and hold the humidifier button on the CPAP device until the humidifier screen appears. Press the humidifier or ramp buttons to change the setting.



IMPORTANT! The humidifier is turned on whenever the settings menu is entered. It will turn off in 20 minutes if the air flow is not turned on.

IMPORTANT! When the air flow is turned off, the humidifier will automatically shut off. If you restart the air flow, and heated humidification is desired, you must press the humidifier button to reactivate the humidifier.

CLEANING

The water chamber should be cleaned daily or after each use.

WARNING! *Emptying and cleaning the water chamber daily will help to prevent mold and bacteria growth.*

WARNING! *Allow the water in the chamber to cool down to room temperature before removing it from the humidifier.*

WARNING! *To avoid electrical shock, disconnect the power cord and power jumper cord before cleaning the humidifier platform. DO NOT immerse the humidifier platform or power jumper cord into any fluids.*

Water Chamber

1. Turn the CPAP device off and allow approximately 15 minutes for the heater plate and water to cool.
2. Disconnect the tubing from the water chamber. Press down on the water chamber and slide it out of the humidifier platform.
3. Discard any remaining water. Remove the rubber connector from the air inlet. Gently remove the base of the chamber with your hands being careful not to damage the rubber seal. Wash all parts in the dishwasher or a solution of warm water and a mild dishwashing detergent. Rinse with clean water and allow to air dry.
4. Reassemble and fill the water chamber. Inspect the water chamber for any leaks or damage. Replace the water chamber if any damage is present.

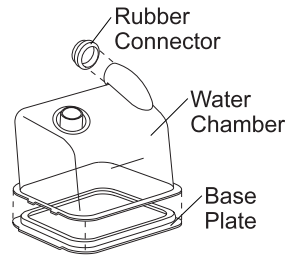

Humidifier Platform

1. Clean the humidifier platform by wiping with a damp cloth. Allow to air dry.
2. Inspect the humidifier platform and power jumper cord for any damage and replace if necessary.

SERVICE

The humidifier does not require routine servicing.

If the humidifier malfunctions or if the LED starts flashing, contact your home care provider immediately. Never attempt to open the humidifier's enclosure.

SPECIFICATIONS

Size	Dimensions: 13.25" x 6.5" x 2.125" (33.7 x 16.5 x 5.4 cm)	
	Weight: < 1.85 lbs. (< .84 kg)	
Water Capacity	1 2/3 cups (400 ml) at recommended water level	
Product Use, Transport, and Storage	Operation	Transport & Storage
	Temperature: 41 to 95° F (5 - 35° C)	-4 to 140° F (-20 to 60° C)
	Humidity: 15 - 95% Non-condensing	15 - 95% Non-condensing
	Atmospheric Pressure: 76.7 - 102 kPascals	50 - 102 kPascals
Standards Compliance	<p>This humidifier is designed to conform to the following standards:</p> <ul style="list-style-type: none"> IEC 60601-1-1998 General Requirements for Safety IEC 60601-2-1993 Electromagnetic Compatibility EN ISO 8185:1998 General Requirements for Humidification Systems US Deviations (UL 2601) Canada Deviations (C22.2 601.1) 	
Power Requirements	<p>AC Power Consumption: 100 - 240 VAC, 50/60 Hz, 1.0 A max. Power Jumper Cord Output: 100 - 240 VAC, 50/60 Hz, 1.0 A max.</p>	
Type of Protection against Electric Shock	Class II Equipment	
Degree of Protection against Electric Shock	Type BF Applied Part	
Equipment Type	IPX0 - Ordinary Equipment	
Heater Settings	1 to 5 (104 to 149° F / 40° to 65° C)	
Pressure Drop w/ Humidifier	0.3 cm H ₂ O over the range of operating pressures	
Humidity Range	10-40 mg H ₂ O/L	
LED Type	Type 1 per IEC 60825-1	

TRAVELING WITH THE SYSTEM

Packing the System

When traveling, the optional CPAP carrying case is for carry-on luggage only. The carrying case will not protect the humidifier if it is put through checked baggage.

Security Stations

For ease at security stations, there is a note on the bottom of the humidifier stating that it is medical equipment. It may be helpful to bring this manual along with you for security personnel.

DC Power

DC to AC inverters cannot be used with this humidifier; damage could occur to the humidifier.

Checking the Power Cord

If you are traveling to a country with a line voltage different than the one you are currently using, an international plug adapter may be required to make your power cord compatible with the power outlets of the country to which you are traveling.

IMPORTANT!

For more information, contact Respironics Customer Service department at 1-800-345-6443 (US and Canada) or 1-412-731-2100.

WARRANTY

Respironics, Inc.[®] warrants that this humidifier shall be free from defects of workmanship and materials and will perform in accordance with the product specifications for a period of one (1) year from the date of sale by Respironics, Inc. to the dealer. If the product fails to perform in accordance with the product specifications, Respironics, Inc. will repair or replace, at its option, the defective material or part. Respironics, Inc. will pay customary freight charges from Respironics, Inc. to the dealer location only. This warranty does not cover damage caused by accident, misuse, abuse, alteration and other defects not related to material or workmanship. To exercise your rights under this warranty, contact your local, authorized Respironics, Inc. dealer or Respironics.



RESPIRONICS INC.[®]

1001 Murry Ridge Lane
Murrysville, Pennsylvania
15668-8550 USA

RESPIRONICS[®]

Deutschland
Gewerbestrasse 17
82211 Herrsching Germany

