

## Warranty

Respironics, Inc warrants the InnoSpire Mini compressor to be free from defects in materials and workmanship under normal use and operation for a period of 3 years from date of purchase from Respironics, Inc. The warranty is limited to repair or replacement, at Respironics, Inc's sole option, of any such component or equipment claimed to be defective when claim is shown to be bona fide by evaluation by Respironics, Inc. This warranty does not extend to any components or equipment subjected to misuse, improper operation, accidental damage, or unauthorized repairs, and is not extended to charges of, or for, labor repairs. All items returned must be properly packaged and shipped, prepaid, by the distributor servicing the unit. Respironics, Inc shall not be liable to purchaser or others for loss of use of equipment or for indirect, or incidental or consequential damages that might arise.

Respironics Respiratory Drug Delivery (UK) Limited Made in China.

## Garantie

Respironics, Inc. garantit que le compresseur InnoSpire Mini ne comporte aucun défaut de matériau ou de fabrication dans des conditions d'utilisation et de fonctionnement normales pendant une période de 3 ans à compter de la date d'achat à Respironics, Inc. La garantie est limitée à la réparation ou au remplacement, au choix exclusif de Respironics, Inc., de tout composant ou équipement pouvant être défectueux, selon la détermination effectuée à la suite d'une évaluation en toute bonne foi effectuée par Respironics, Inc. La présente garantie ne s'étend pas à tous composants ou équipements ayant été soumis à une utilisation inappropriée ou abusive, à un endommagement accidentel ou à des réparations non autorisées, et elle ne couvre pas les frais de main-d'œuvre associés à toute réparation. Tous les articles renvoyés doivent être conditionnés de façon appropriée et expédiés en frais payés par le distributeur du produit chargé du service après-vente du dispositif. Respironics, Inc. n'assume aucune responsabilité envers l'acheteur ou toute autre partie pour la privation d'utilisation de l'équipement ou pour de quelconques dommages indirects, accessoires ou secondaires pouvant survenir.

Respironics Respiratory Drug Delivery (UK) Limited - Fabriqué en Chine.

## Garantía

Respironics, Inc garantiza que el compresor InnoSpire Mini está libre de defectos en materiales y mano de obra bajo el uso y la operación normal, por un período de 3 años desde la fecha de compra a Respironics, Inc. La garantía se limita a reparar o reemplazar, a opción exclusiva de Respironics, Inc., cualquier componente o equipo considerado como defectuoso, cuando se demuestre que la reclamación es de buena fe según la evaluación hecha por Respironics, Inc. Esta garantía no se extiende a los componentes o equipos sometidos al uso erróneo, operación impropia, daños accidentales o reparaciones no autorizadas, y no se extiende a cargos de o para mano de obra para reparaciones. Todos los artículos devueltos deben estar empacados en forma apropiada y deben ser enviados con franqueo prepago por el distribuidor que ofrezca el servicio para la unidad. Respironics, Inc. no será responsable ante el comprador o terceros por la pérdida de uso del equipo ni por daños indirectos, incidentales o consiguientes que pudiesen surgir.

Respironics Respiratory Drug Delivery (UK) Limited Fabricado en China.

InnoSpire Mini is a trademark of of Koninklijke Philips N.V. and its affiliates, all rights reserved.

© 2013 Koninklijke Philips N.V. All rights are reserved.

Manufactured for

Respironics Respiratory Drug Delivery (UK) Ltd  
Chichester Business Park, City Fields Way  
Tangmere, Chichester PO20 2FT UK

[www.phillips.com/respironics](http://www.phillips.com/respironics)

PN 1114277 R00



**PHILIPS**  
**RESPIRONICS**

## InnoSpire Mini

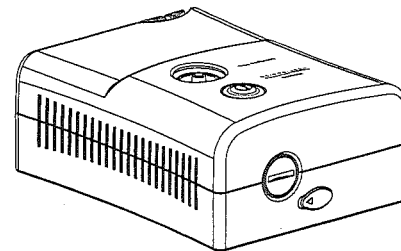

## Compressor nebulizer system

**CAUTION:** Federal (USA) law restricts this device to sale by or on the order of a physician or licensed healthcare professional.

## Système de nébuliseur à compresseur

**MISE EN GARDE :** Aux États-Unis, la loi fédérale limite la vente de ce dispositif aux médecins ou autres professionnels de la santé dûment agréés, ou sur leur ordonnance.

## Sistema de nebulizador a compresor

**PRECAUCIÓN:** Las leyes federales (EE.UU.) limitan la venta de este dispositivo a un médico o profesional sanitario con licencia o bajo sus órdenes.

# InnoSpire Mini

## InnoSpire Mini compressor (back view)

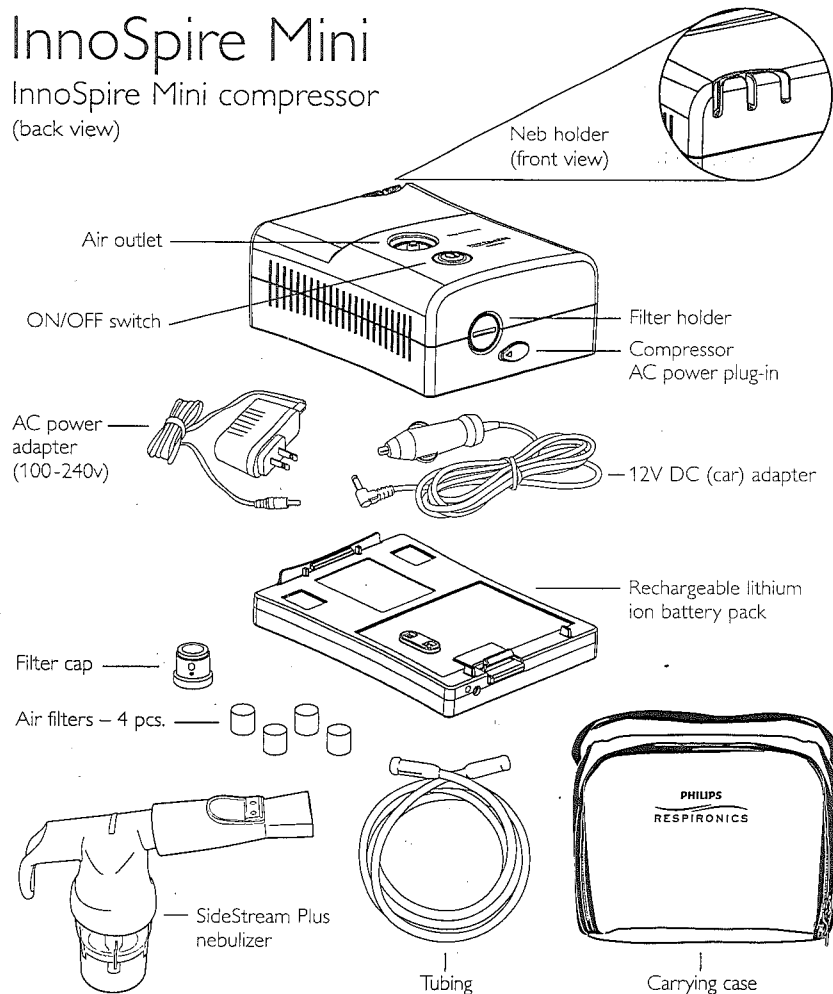

Read these instructions before using this compressor. If you do not understand any portion of these instructions, contact your healthcare provider or call Philips Respironics Customer Service at 1-800-345-6443 or 1-724-387-4000.

### Intended use statement

The InnoSpire Mini is intended to provide a source of compressed air for medical purposes. It is to be used with a pneumatic (jet) nebulizer to produce aerosol particles of medication for respiratory therapy for both children and adults.

### Unpacking your InnoSpire Mini system

When you unpack your InnoSpire Mini from its shipping case:

- Carefully examine the contents against items listed and for damage. Make sure you have all the content items listed and that they are not damaged.
- Save these Instructions for use for reference.
- Report anything missing or damaged to Philips Respironics.

Note: Retain carton and packing materials for storing the unit or for product returns.

### Read these warnings and cautions before using your InnoSpire Mini

#### ⚠ Warnings and cautions

It is recommended to have a backup device (e.g. MDI) for respiratory delivery in case a situation arises when your nebulizer cannot be used (e.g. during a power outage or if your compressor and/or battery becomes inoperable for any reason).

#### ⚠ DANGER – To reduce the risk of electrocution:

- Always unplug this compressor immediately after using.
- Do not place or store product where it can fall or be pulled into a tub or sink.
- Do not place in or drop into water or other liquid.
- Do not reach for product that has fallen into water. Unplug immediately.

**Electromagnetic information:** Portable and RF communication devices such as cellular phones, pagers, etc. can interrupt operation of electrical medical equipment. For this reason, your compressor must be placed far enough away from these devices to prevent interference. This device meets the IEC60601-1-2 Standard for Electromagnetic Compatibility (EMC). EMC data sheets are available upon request from Philips Respironics Customer Service at 1-800-345-6443 or 1-724-387-4000. The CE mark on the product denotes compliance with all applicable EU

Directives. Note that the Notified Body number does not apply to the RoHS (restriction of the use of certain hazardous substances in electrical and electronic equipment) Directive.

**⚠ WARNING** – To reduce the risk of burns, electrocution, fire or injury to persons:

- Do not operate compressor while it is in carrying case.
- A compressor should never be left unattended when plugged in.
- Adult supervision is necessary when this product is used by, on, or near children or physically challenged individuals.
- Use this product only for its intended use as described in this manual. Failure to do so may compromise performance. Do not use nebulizers or accessories not recommended by the manufacturer.
- Never operate this product if it has a damaged cord or plug, if it is not working properly, if it has been dropped or damaged, or dropped into water.
- Do not use with an extension cord.
- Do not use this device in-line in a ventilator circuit.
- Keep the power cord away from heated surfaces.
- **This unit has been designed for intermittent use: 30 minutes ON / 30 minutes OFF. Failure to operate appropriately may lead to device damage.**
- To avoid the risk of possible electrical shock, the compressor must be operated using the specified power sources.
- Do not remove the compressor housing or disassemble unit. There are no serviceable parts.
- Never use while sleeping or drowsy.
- Do not use while operating a vehicle.
- InnoSpire Mini and all its parts must be disposed of according to the local regulations in force.
- Do not stack the compressor with other equipment.
- Small parts can be inhaled, swallowed or dangerous. Cable, due to its length, may result in provoking strangulation or asphyxiation. Do not leave the device alone with a small child or physically challenged individual or individual with learning difficulties.
- People who require assistance might underestimate the risks involved, such as strangulation, therefore they should be supervised.
- Device should not be used around flammable substances, in an oxygen rich environment, or in the presence of a flammable anaesthetic mixture with air, oxygen or nitrous oxide.
- Use the product in a clean environment, one that is free from dirt, dust, pet hair etc.

- Do not use the compressor on a bed/blanket to avoid overheating.
- In case of accidental spillage of water or any liquid, dry the compressor immediately, and then allow any residual moisture to dry completely before operating.

**⚠** Save these instructions

## How to use your InnoSpire Mini

- 1** Check the nebulizer and compressor for damage. Read the nebulizer instructions prior to use.
- 2** Place your InnoSpire Mini compressor on a firm, flat surface near an electrical outlet (if using AC power) and where you can be seated comfortably during your treatment. Do not hold the compressor in hand during treatment.
- 3** To use the compressor with the AC power adapter, connect the AC power adapter into the power plug-in on the back of the compressor. Then connect the other end into the electrical outlet.
- 4** Alternatively the unit can be used with the rechargeable battery pack or 12V DC (car) adapter: Read the section relating to the rechargeable battery pack carefully. Use only with 12V vehicle electrical system.
- 5** Do not operate the unit without the filter or with a clogged (dirty) or wet filter: Operating the unit with a dirty filter can impair proper operation and cause damage that is not covered by the warranty.
- 6** Wash your hands before beginning your treatment.
- 7** Assemble your nebulizer and add your prescribed medicine following your prescription and the separate nebulizer instructions.
- 8** Connect one end of the tubing to the bottom of the nebulizer and the other end of the tubing to the air outlet on the compressor.
- 9** Turn the power on/off switch to begin your treatment. A green light appears indicating that the unit is on.
- 10** When your treatment is complete, turn the power on/off switch and unplug the unit if using AC power or 12V DC (car) adapter.
- 11** Clean the nebulizer according to its instructions.

# InnoSpire Mini

## Rechargeable lithium ion battery

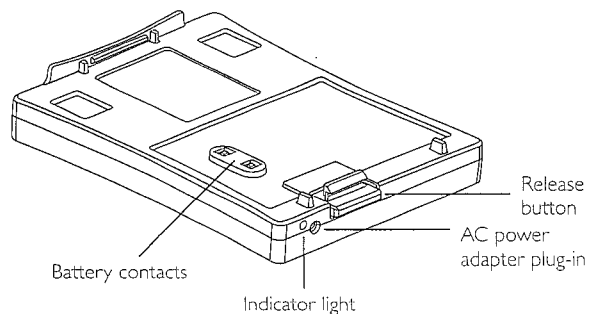

Read these instructions before using this battery

The battery will not charge when it is connected to the compressor

 Read these warnings and cautions before using this battery

### Warnings and cautions

- Use only with Philips Respironics Innospire Mini compressor and power adapter.
- Do not immerse in water.
- Do not use battery if accidentally dropped in water.
- Do not touch with wet or moist hands.
- Do not dispose of in fire.
- Do not expose to direct sunlight, chemicals, high temperatures or humidity.
- Do not allow metal objects to touch metal parts of the battery as it may result in a short circuit.
- Do not disassemble.
- Do not try to operate the compressor while charging the battery as the compressor will not operate.

How to attach and detach the rechargeable lithium ion battery

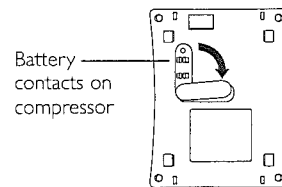

- 1 Shift the contact cover on the bottom of the Innospire Mini compressor so the battery contacts are uncovered.

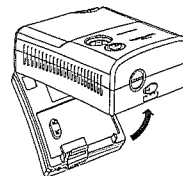

- 2 To attach the battery, align the back end of the Innospire Mini compressor into the back end of the rechargeable lithium ion battery.

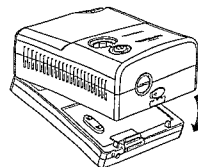

- 3 Fit the front end of the compressor down until it engages with a "click" into the front end of the rechargeable lithium ion battery.

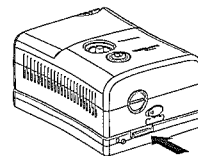

- 4 To remove the rechargeable lithium ion battery, lift the front of the compressor off the battery while pressing the release button on the rechargeable lithium ion battery.

## Charging the battery

- 1 Charge the battery pack fully prior to first use.
- 2 Connect the AC or 12V DC car adapter to the power adapter plug-in on the front side of the battery.
- 3 Plug the other end of the AC or DC car adapter into the wall outlet or 12V DC car outlet.
- 4 The battery indicator light will turn orange.
- 5 Charge the battery until the battery indicator turns green. It may take up to 6 hours to fully charge the battery.
- 6 Unplug the power adapter from both the battery power plug-in and the wall outlet or 12V DC car outlet.

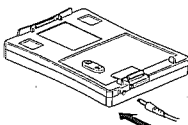

## Storing the battery

- 1 Store the battery fully charged in a cool dry place.
- 2 Every 1-2 months, fully charge the battery to maintain maximum battery capacity.
- 3 It may take up to 5 charge/discharge cycles to return the battery to maximum capacity after prolonged storage.

## Battery indicator lights

- 1 The battery indicator light will turn orange when the battery is being charged.
- 2 The battery indicator light will turn green when the battery is fully charged while still connected to charging source.
- 3 The battery indicator light will blink orange when the battery is almost exhausted/drained.
- 4 The light is off under the following conditions:
  - when the battery has charge and is not connected to a charging source
  - when battery is fully discharged
  - when battery enters a fault condition

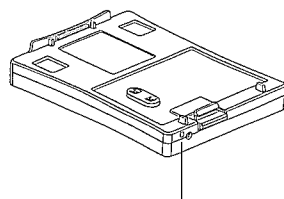

Indicator light

**CAUTION:** Clean the device, according to instructions, between patients when used on multiple patients.

## Care and cleaning of your InnoSpire Mini

**CAUTION:** To reduce risk of electric shock, DO NOT DISASSEMBLE and never submerge or place under running water.

- 1 Unplug the compressor before cleaning.
- 2 Use a damp cloth to wipe down the outside of the compressor as required. Do not use abrasive cleaners.
- 3 Check the filter periodically and replace the filter when dirty.

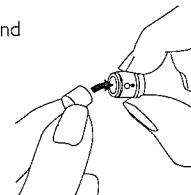

- 4 To change the filter:
  - Use a coin to unscrew the filter holder (Note: Turn clockwise to unscrew).

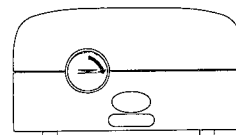

InnoSpire Mini compressor  
(back view)

- Pull out filter and replace with new filter.

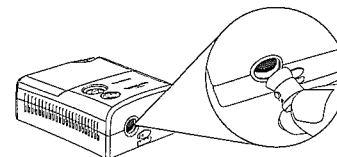

- Screw filter holder back on by turning counter clockwise.

- 5 After each cleaning, check that the unit is working properly by verifying that air still comes out of the nozzle when the unit is turned to the "on" position and that the unit's noise level has not increased. (Increased noise indicates improper filter positioning.)
- 6 The compressor is oil-free. Do not lubricate.

## Troubleshooting

Problems	Solutions
Compressor overheats. The compressor has an internal thermal protector to prevent the device from overheating. If the internal temperature reaches the preset level, the unit will automatically shut down, and the ON/OFF button light will turn red.	<p>The thermal protector has been activated due to:</p> <ol style="list-style-type: none"> <li>The device operating outside the conditions outlined in this manual.</li> <li>The device has been operating near heat sources or in hot environments.</li> </ol> <p>Allow the compressor to cool down for a minimum of 40 minutes. Wait until the red light turns off before turning the compressor on again.</p>
The compressor does not operate.	Check all power sources to the compressor. Push the ON/OFF button again.
Medication does not nebulize properly.	<p>Check for proper connection of the tubing adapter.</p> <p>Make sure the nebulizer is not empty.</p> <p>Clean the nebulizer as described in the manual.</p> <p>Replace the nebulizer.</p> <p>Check the intake filter and replace it if it is dirty.</p>
The device is noisy.	Check that the filter cover is correctly positioned.
The compressor does not operate when connected to battery.	<p>Make sure battery contacts cover is removed</p> <p>Check the assembly of the battery pack to compressor</p> <p>Compressor is disabled when battery is charging. Remove charger from battery to operate the compressor.</p> <p>Ensure battery pack has adequate charge. Recharge battery.</p> <p>Short circuit protection may have been activated. This fault condition can be re-set by charging the battery pack.</p>

Should the device still not operate properly after checking the unit as indicated above, contact Philips Respironics Customer Service at 1-800-345-6443 or 1-724-387-4000.

## Specifications

Power supply	See adapter rating label
Weight	0.93 lbs.
Size	4.5" x 3.5" x 2.1" (114.3 mm x 88.9 mm x 53.3 mm)
Noise level	50 +/- 4dBA
Average flow rate	3.4 LPM @12.7 psi
Maximum pressure	30 psi
Maximum flow rate	~ 8 LPM
Mode of operation	Intermittent use 30 min ON / 30 min OFF

Class II device (double safety insulation).  
Type BF device (device with specific protection against electrical hazards).

## Certification

Electric safety standards EN 60601-1  
Electromagnetic compatibility according to EN 60601-1-2

## Storage conditions

Temperature	MIN -4° F MAX 140° F (MIN -20° C MAX +60° C)
Humidity	MIN 10% RH -MAX 95% RH
Atmospheric pressure	Performance may vary depending on altitude above sea level, barometric pressure and temperature

## Operating conditions

Temperature	MIN 41° F MAX 104° F (MIN +5° C MAX +40° C)
Humidity	MIN 10% RH -MAX 95% RH
Atmospheric pressure	Performance may vary depending on altitude above sea level, barometric pressure and temperature















## Expected service life

Compressor 3 years from date of purchase  
Battery 6 months from date of purchase

## Replacement parts and accessories

Filter	1109488
AC power/battery charger	1109441
12V DC (car) adapter	1109455
Rechargeable lithium ion battery	1110726

## Symbol glossary

 Attention: Read accompanying documents	 Serial number	 Double insulated
 ON (power)	 Alternating current	 Type BF applied parts
 OFF (power)	 Direct current	 Indoor use only
 Follow instructions for use	 Atmospheric pressure	 Humidity
 Temperature limitation	 Separate collection	

**IP22** Housing Ingress Protection Rate: IP22 (Protected against solid foreign objects of 12.5 mm Ø and greater; Protected against vertically falling water drops when ENCLOSURE tilted up to 15°)

## Optional rechargeable battery

## Specifications

Operating time with battery	Up to 90 minutes
Number of treatments per charge	Up to 12 treatments when nebulizing 2.5 ml of medication
Normal time to charge	Approximately 6 hours

## Operating conditions

Temperature	MIN 41° F MAX 104° F (MIN +5° C MAX +40° C)
-------------	---

## Storage conditions

Temperature	MIN -4° F MAX 140° F (MIN -20° C MAX +60° C)
-------------	--